

**DoubleZero7**

Track System, *design by* Lodes

*Model* Trimless Recessed Profile

*DoubleZero7* is an open and reconfigurable system that brings together the different languages of light – architectural, decorative and functional – combining lighting precision, compositional freedom and aesthetic value within a single, coherent vision. *DoubleZero7* is Lodes' first opentrack system.

A lighting infrastructure designed not only to accommodate dedicated architectural lighting modules, but also to be compatible with all the suspension lights in the catalogue. The track runs through the space like a graphic line, creating fluid and consistent scenarios in which technical function becomes part of the decorative gesture, naturally adapting to every type of setting – from residential to hospitality, from retail to contract environments.



CATEGORY 007 TRACK SYSTEM **NEW**

DESIGN Lodes, 2026

**DOUBLEZERO7** TRIMLESS RECESSED

## Trimless Recessed Profile

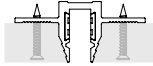
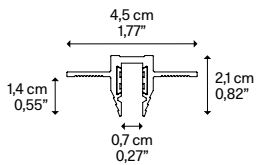
Description  
Descrizione

48V trimless recessed track profile, available in three lengths. Aesthetic finishing cover included. Protective cover and aesthetic finishing cover included.

Profilo a binario 48V per installazione ad incasso trimless, disponibile in tre lunghezze. Cover protettiva e cover estetica di finitura incluse.

Metal structure  
Montatura in metallo

- Extra Matte Black Nero Extra Opaco
- Extra Matte Black Nero Extra Opaco
- Extra Matte Black Nero Extra Opaco

Track length  
Lunghezza binario

A 1 m - 39,37"

B 2 m - 78,74"

C 3 m - 118,11"

Code  
Codice

T07E100 20

T07E200 20

T07E300 20

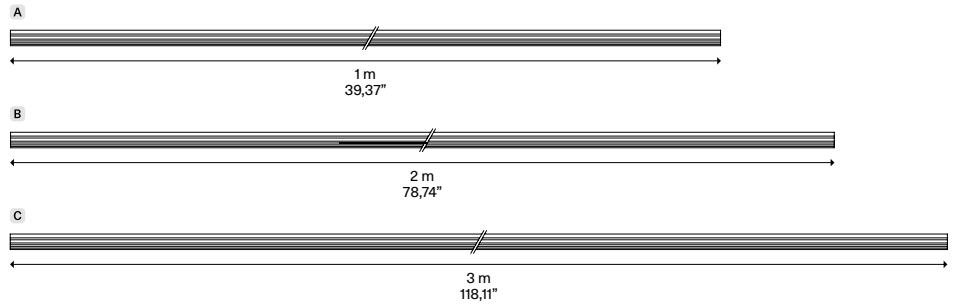

Net weight 500 g/m<sup>2</sup> Pack  
Peso netto 1,10 lbs/m<sup>2</sup> Colli 1

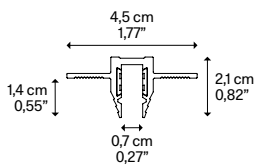
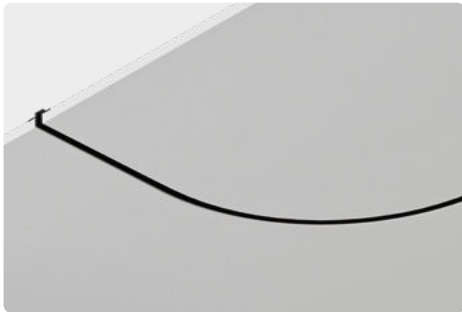

## Trimless Recessed 90° Curve

Description  
Descrizione

90° curved element - 30 cm / 11,81" radius for the Trimless Recessed track, for creating curves on the same installation plane. Protective cover and aesthetic finishing cover included.

Elemento curvo a 90° - raggio 30 cm / 11,81" per il binario Trimless Recessed, per realizzare curve sullo stesso piano di installazione. Cover protettiva e cover estetica di finitura incluse.

Metal structure  
Montatura in metallo

- Extra Matte Black Nero Extra Opaco

Track curvature  
Curvatura binario

D 90° R30

Code  
Codice

T07ER30 20

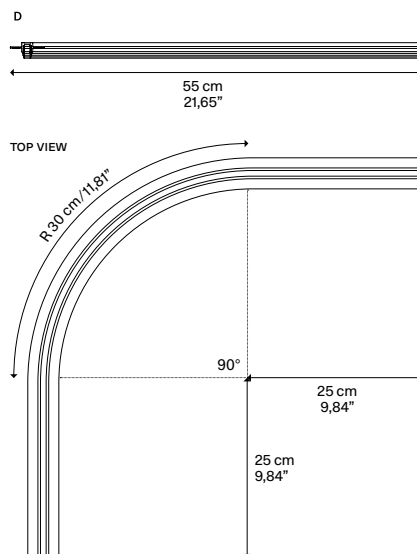

Net weight 375 g Pack  
Peso netto 0,82 lbs Colli 1



CATEGORY 007 TRACK SYSTEM ACCESSORY

NEW

DESIGN Lodes, 2026

DOUBLEZERO7 TRIMLESS RECESSED

## Flat Corner

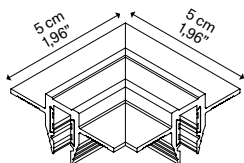

Net weight	20 g	Pack	1
Peso netto	0,04 lbs	Colli	

Description  
Descrizione

90° corner element for connecting two Trimless Recessed track sections on the same plane.

Elemento angolare a 90° per collegare due segmenti di binario Trimless Recessed sullo stesso piano.

Metal structure  
Montatura in metallo

● Extra Matte Black  
Nero Extra Opaco

Corner  
Angolo

IN-PLANE

Code  
Codice

T07EF90 20



## Internal Corner

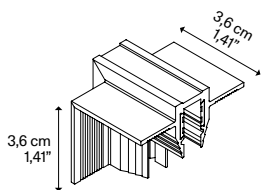

Net weight	20 g	Pack	1
Peso netto	0,04 lbs	Colli	

Description  
Descrizione

Internal 90° corner element for connecting two Trimless Recessed track sections around an inside angle.

Elemento angolare interno a 90° per collegare due segmenti di binario Trimless Recessed in un angolo rientrante.

Metal structure  
Montatura in metallo

● Extra Matte Black  
Nero Extra Opaco

Corner  
Angolo

INTERNAL

Code  
Codice

T07EI90 20



## External Corner

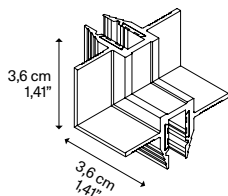

Net weight	20 g	Pack	1
Peso netto	0,04 lbs	Colli	

Description  
Descrizione

External 90° corner element for connecting two Trimless Recessed track sections around an outside angle.

Elemento angolare esterno a 90° per collegare due segmenti di binario Trimless Recessed in un angolo sporgente.

Metal structure  
Montatura in metallo

● Extra Matte Black  
Nero Extra Opaco

Corner  
Angolo

EXTERNAL

Code  
Codice

T07EE90 20



CATEGORY 007 TRACK SYSTEM ACCESSORY **NEW****DOUBLEZERO7** TRIMLESS RECESSED

## Joint Connector

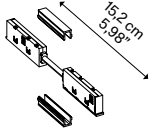

Net weight	0,15 g	Pack	1
Peso netto	0,03 lbs	Colli	

Description  
Descrizione

Electrical connector ensuring power continuity between two track sections, suitable for both linear connections and corner elements.

Connettore elettrico per garantire la continuità dell'alimentazione tra due segmenti di binario, sia in connessioni lineari che negli elementi angolari.

Metal structure  
Montatura in metallo

● Extra Matte Black  
Nero Extra Opaco

Code  
Codice

T07J001

48V ON/OFF Driver  
for Remote installation

Net weight	97W	160 g	Pack	1
Peso netto		0,35 lbs	Colli	
	200W	320 g		
		0,70 lbs		

Description  
Descrizione

48V ON/OFF driver for remote installation, powering the track up to a total load of 96W or 200W.

Driver 48V ON/OFF per installazione remota, che alimenta il binario fino a un carico totale di 96W o 200W.

Metal structure  
Montatura in metallo

● Extra Matte Black  
Nero Extra Opaco

● Extra Matte Black  
Nero Extra Opaco

Power  
Potenza

96 w

200 w

Code  
Codice

T07ED01 00

T07ED02 00

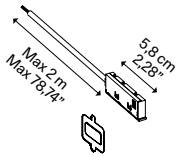
Feed Connector  
for Remote-Driver installation

Net weight	100 g	Pack	1
Peso netto	0,22 lbs	Colli	

Description  
Descrizione

Electrical connector for powering the track from one end in remote-driver installations and for connecting a DALI BUS. Includes an installation key for the Trimless Recessed profile.

Connettore elettrico per alimentare il binario da un'estremità nelle installazioni con driver remoto e per collegare un bus DALI. Include una chiave di installazione per il profilo Trimless Recessed.

Metal structure  
Montatura in metallo

● Extra Matte Black  
Nero Extra Opaco

Code  
Codice

T07J002



---

## DOUBLEZERO7 Track Light Modules

### CLUSTER CLIP



### Bambi SPOTLIGHT



### Solitaire WALLWASHER



### Camille GENERAL LIGHT



### Severine LIGHT LINE

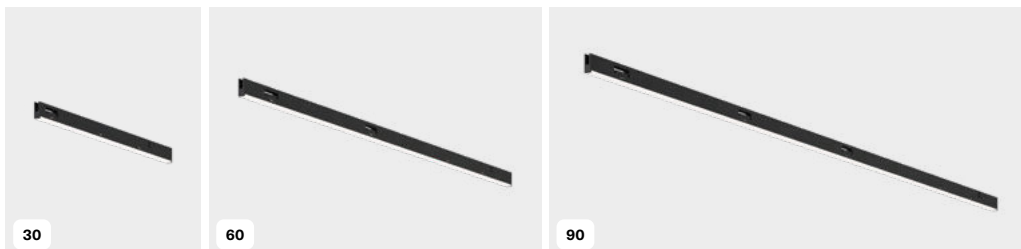

CATEGORY 007 TRACK LIGHT MODULES **NEW**

DESIGN Lodes, 2026

**DOUBLEZERO7**

## Cluster Clip

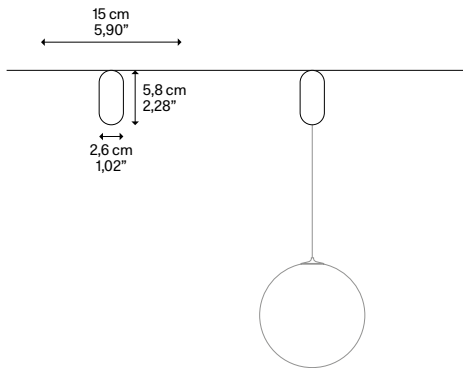

**Description**  
Descrizione

Adapter with integrated clip for connecting and installing Lodes Cluster pendants on the track. Compatible lamps are shown in the dedicated section below.

Adattatore con clip integrata per collegare e installare le sospensioni Cluster di Lodes sul binario. Le lampade compatibili sono riportate nella sezione dedicata sotto.

**Metal structure**  
Montatura in metallo

- Extra Matte Black  
Nero Extra Opaco
- Extra Matte Champagne  
Champagne Extra Opaco
- Extra Matte Black  
Nero Extra Opaco
- Extra Matte Champagne  
Champagne Extra Opaco

**Type of dimming**  
Tipo di dimmerazione

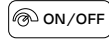

**Code**  
Codice

T07001 20  
T07001 45  
T07101 20  
T07101 45

Net weight 65 g  
Peso netto 0,14 lbs

Pack Colli 1



## Lodes lamps suitable for DOUBLEZERO7

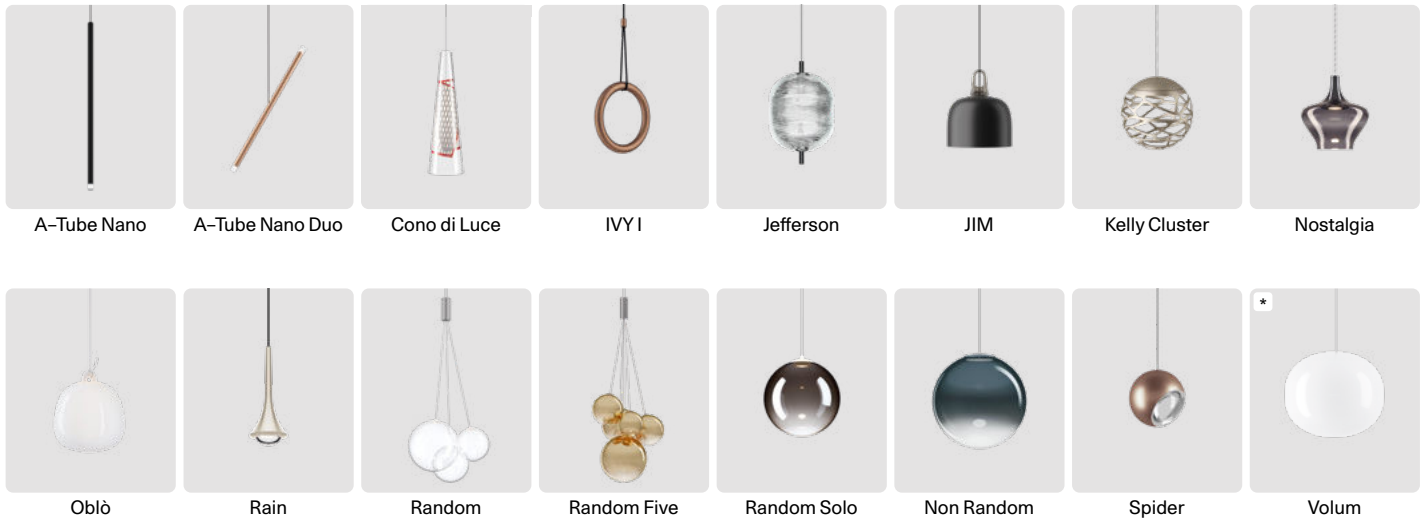

\* Volum cluster suspension on the DOUBLEZERO7 system must use the following bulbs, which have to be ordered separately.  
Volum sospensione cluster sul sistema DOUBLEZERO7 deve necessariamente utilizzare le seguenti lampadine, da ordinare separatamente.

Light source Sorgente luminosa	Lamp Lampada	System Sistema	Pack Colli	Code Codice
E14 5,1 W	2700 K 570 lm CRI 90 MacAdam 3-Step	Volum 14	1	LAM-0033
E27 9,1 W	2700 K 960 lm CRI 90 MacAdam 3-Step	Volum 22	1	LAM-0034

CATEGORY 007 TRACK LIGHT MODULES **NEW**

DESIGN Lodes, 2026

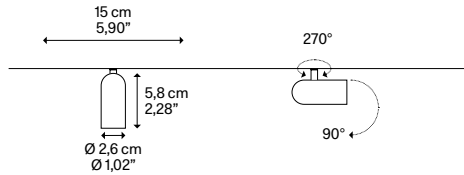
**DOUBLEZERO7****Bambi 26 SPOTLIGHT**

**Description**  
Descrizione

Compact 48V spotlight for the DOUBLEZERO7 track system.

Proiettore compatto a 48V per installazione su binario DOUBLEZERO7.

**Optics**  
Ottica

The product is supplied with three interchangeable optics and an integrated honeycomb louvre.

Il prodotto viene fornito con tre ottiche intercambiabili e filtro honeycomb inclusi.

**Metal structure**  
Montatura in metallo

● Extra Matte Black  
Nero Extra Opaco

● Extra Matte Champagne  
Champagne Extra Opaco

● Extra Matte Black  
Nero Extra Opaco

● Extra Matte Champagne  
Champagne Extra Opaco

**Type of dimming**  
Dimmerazione



**Code**  
Codice

T07061 2027

T07061 4527

T07161 2027

T07161 4527

**Code** **A**  
Codice

T07061 2030

T07061 4530

T07161 2030

T07161 4530

**Beam angle**  
Angolo del fascio

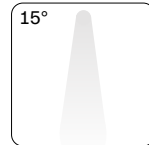

SPOT

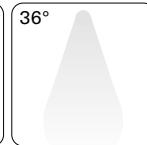

MEDIUM

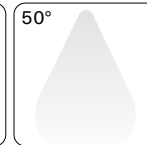

WIDE

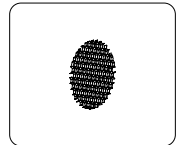

HONEYCOMB LOUVRE

**Light source** **A**  
Sorgente luminosa

LED  
2700 K  
4 W  
512 lm  
CRI 90  
MacAdam 3-Step

**Light source** **B**  
Sorgente luminosa

LED  
3000 K  
4 W  
528 lm  
CRI 90  
MacAdam 3-Step

Net weight 60 g  
Peso netto 0,13 lbs

Pack Colli 1

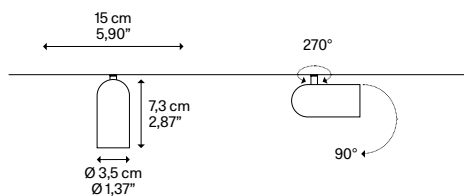
**Bambi 35 SPOTLIGHT**

**Description**  
Descrizione

Compact 48V spotlight for the DOUBLEZERO7 track system.

Proiettore compatto a 48V per installazione su binario DOUBLEZERO7.

**Optics**  
Ottica

The product is supplied with three interchangeable optics and an integrated honeycomb louvre.

Il prodotto viene fornito con tre ottiche intercambiabili e filtro honeycomb inclusi.

**Metal structure**  
Montatura in metallo

● Extra Matte Black  
Nero Extra Opaco

● Extra Matte Champagne  
Champagne Extra Opaco

● Extra Matte Black  
Nero Extra Opaco

● Extra Matte Champagne  
Champagne Extra Opaco

**Type of dimming**  
Dimmerazione

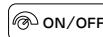

**Code**  
Codice

T07062 2027

T07062 4527

T07162 2027

T07162 4527

**Code** **A**  
Codice

T07062 2030

T07062 4530

T07162 2030

T07162 4530

**Beam angle**  
Angolo del fascio

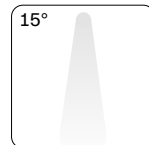

SPOT

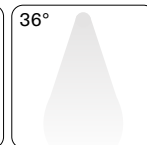

MEDIUM

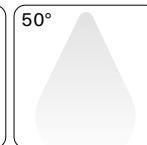

WIDE

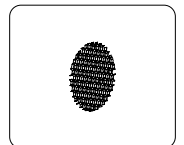

HONEYCOMB LOUVRE

**Light source** **A**  
Sorgente luminosa

LED  
2700 K  
8 W  
768 lm  
CRI 90  
MacAdam 3-Step

**Light source** **B**  
Sorgente luminosa

LED  
3000 K  
8 W  
792 lm  
CRI 90  
MacAdam 3-Step

Net weight 120 g  
Peso netto 0,26 lbs

Pack Colli 1



CATEGORY 007 TRACK LIGHT MODULES **NEW**

DESIGN Lodes, 2026

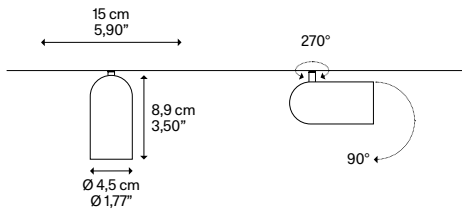
**DOUBLEZERO7****Bambi 45 SPOTLIGHT****Description**  
Descrizione

Compact 48V spotlight for the DOUBLEZERO7 track system.

Proiettore compatto a 48V per installazione su binario DOUBLEZERO7.

**Optics**  
Ottica

The product is supplied with three interchangeable optics and an integrated honeycomb louvre.

Il prodotto viene fornito con tre ottiche intercambiabili e filtro honeycomb inclusi.

**Metal structure**  
Montatura in metallo

● Extra Matte Black  
Nero Extra Opaco

● Extra Matte Champagne  
Champagne Extra Opaco

● Extra Matte Black  
Nero Extra Opaco

● Extra Matte Champagne  
Champagne Extra Opaco

**Type of dimming**  
Dimmerazione**Code**  
Codice

T07063 2027

T07063 4527

T07163 2027

T07163 4527

**Code** **A**  
Codice

T07063 2030

T07063 4530

T07163 2030

T07163 4530

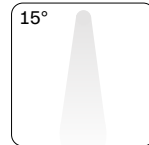
**Beam angle**  
Angolo del fascio

SPOT

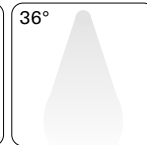

MEDIUM

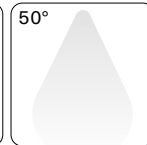

WIDE

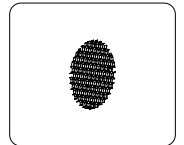

HONEYCOMB LOUVRE

**Light source** **A**  
Sorgente luminosa

LED  
2700 K  
12 W  
1340 lm  
CRI 90  
MacAdam 3-Step

**Light source** **B**  
Sorgente luminosa

LED  
3000 K  
12 W  
1390 lm  
CRI 90  
MacAdam 3-Step

Net weight 220 g  
Peso netto 0,48 lbs

Pack Colli 1

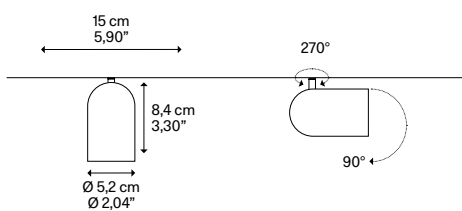
**Solitaire WALLWASHER****Description**  
Descrizione

Compact 48V wallwasher spotlight for installation on the DOUBLEZERO7 track system.

Proiettore compatto wallwasher a 48V per installazione su binario DOUBLEZERO7.

**Optics**  
Ottica

The wallwasher optic is designed to provide uniform illumination of walls and vertical surfaces.

L'ottica wallwasher è progettata per garantire un'illuminazione uniforme di pareti e superfici verticali.

**Metal structure**  
Montatura in metallo

● Extra Matte Black  
Nero Extra Opaco

● Extra Matte Champagne  
Champagne Extra Opaco

● Extra Matte Black  
Nero Extra Opaco

● Extra Matte Champagne  
Champagne Extra Opaco

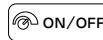
**Type of dimming**  
Dimmerazione**Code** **A**  
Codice

T07051 2027

T07051 4527

T07151 2027

T07151 4527

**Code** **B**  
Codice

T07051 2030

T07051 4530

T07151 2030

T07151 4530

**Beam angle**  
Angolo del fascio

WALLWASHER

**Light source** **A**  
Sorgente luminosa

LED  
2700 K  
10 W  
1970 lm  
CRI 90  
MacAdam 3-Step

**Light source** **B**  
Sorgente luminosa

LED  
3000 K  
10 W  
2100 lm  
CRI 90  
MacAdam 3-Step

Net weight 260 g  
Peso netto 0,57 lbs

Pack Colli 1



CATEGORY 007 TRACK LIGHT MODULES **NEW**

DESIGN Lodes, 2026

**DOUBLEZERO7**

## Camille GENERAL LIGHT



**Description**  
Descrizione

Adjustable 48V general light module with micro-prismatic diffuser for the DOUBLEZERO7 track system.

Modulo orientabile a luce diffusa 48V con diffusore microprismatico, per installazione su binario DOUBLEZERO7.

**Metal structure**  
Montatura in metallo

- Extra Matte Black Nero Extra Opaco
- Extra Matte Champagne Champagne Extra Opaco
- Extra Matte Black Nero Extra Opaco
- Extra Matte Champagne Champagne Extra Opaco

**Type of dimming**  
Dimmerazione



**Code**  
Codice

T07031 2027

T07031 4527

T07131 2027

T07131 4527

**Code**  
Codice

T07031 2030

T07031 4530

T07131 2030

T07131 4530

**Beam angle**  
Angolo del fascio

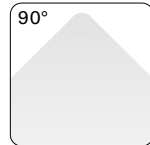

WIDE

**Light source**  
Sorgente luminosa

LED  
2700 K  
12 W  
1896 lm  
CRI 90  
MacAdam 3-Step

**Light source**  
Sorgente luminosa

LED  
3000 K  
12 W  
1902 lm  
CRI 90  
MacAdam 3-Step

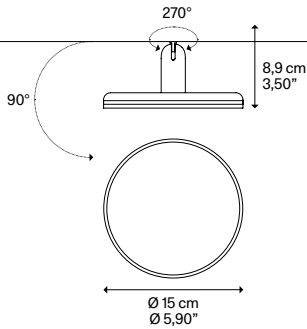

Net weight 360 g  
Peso netto 0,79 lbs

Pack 1  
Colli 1



## Severine 30 LIGHT LINE

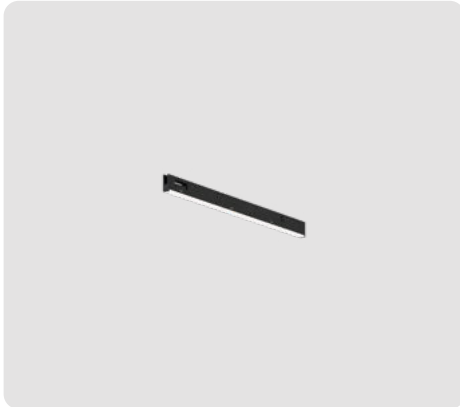

**Description**  
Descrizione

48V light line for installation on the DOUBLEZERO7 track system, 30 cm / 11,81" length.

Linea di luce a 48V per installazione su binario DOUBLEZERO7, lunghezza 30 cm / 11,81".

**Metal structure**  
Montatura in metallo

- Extra Matte Black Nero Extra Opaco
- Extra Matte Black Nero Extra Opaco

**Type of dimming**  
Dimmerazione



**Code**  
Codice

T07091 27

T07191 27

**Code**  
Codice

T07091 30

T07191 30

**Beam angle**  
Angolo del fascio

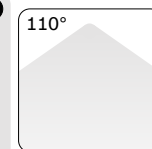

EXTRA WIDE

**Light source**  
Sorgente luminosa

LED  
2700 K  
4 W  
532 lm  
CRI 90  
MacAdam 3-Step

**Light source**  
Sorgente luminosa

LED  
3000 K  
4 W  
544 lm  
CRI 90  
MacAdam 3-Step

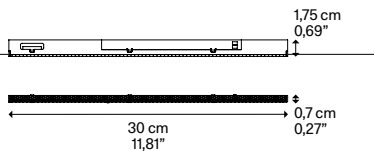

Net weight 60 g  
Peso netto 0,13 lbs

Pack 1  
Colli 1



CATEGORY 007 TRACK LIGHT MODULES **NEW**

DESIGN Lodes, 2026

**DOUBLEZERO7**

## Severine 60 LIGHT LINE

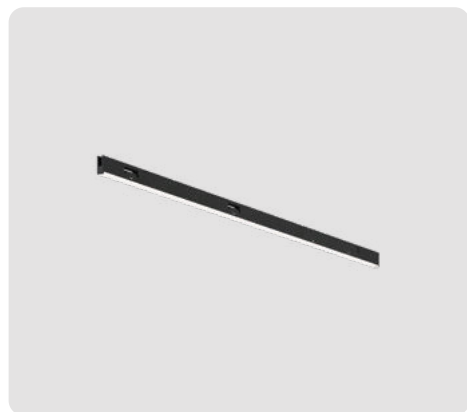
Description  
Descrizione

48V light line for installation on the DOUBLEZERO7 track system, 60 cm / 23,62" length.

Linea di luce a 48V per installazione su binario DOUBLEZERO7, lunghezza 60 cm / 23,62".

Light source  
Sorgente luminosa **A**

LED  
2700 K  
8 W  
1064 lm  
CRI 90  
MacAdam 3-Step

Metal structure  
Montatura in metallo

- Extra Matte Black  
Nero Extra Opaco
- Extra Matte Black  
Nero Extra Opaco

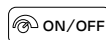
Type of dimming  
DimmerazioneCode  
Codice

T07092 27

**A**Code  
Codice

T07092 30

**B**

T07192 27

T07192 30

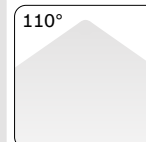
Beam angle  
Angolo del fascio

EXTRA WIDE

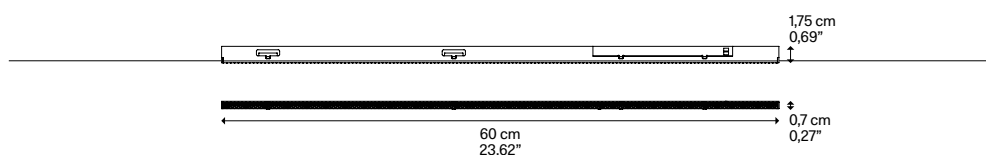

Net weight 100 g  
Peso netto 0,22 lbs

Pack 1  
Colli



## Severine 90 LIGHT LINE

Description  
Descrizione

48V light line for installation on the DOUBLEZERO7 track system, 90 cm / 35,43" length.

Linea di luce a 48V per installazione su binario DOUBLEZERO7, lunghezza 90 cm / 35,43".

Light source  
Sorgente luminosa **A**

LED  
2700 K  
12 W  
1596 lm  
CRI 90  
MacAdam 3-Step

Metal structure  
Montatura in metallo

- Extra Matte Black  
Nero Extra Opaco
- Extra Matte Black  
Nero Extra Opaco

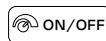
Type of dimming  
DimmerazioneCode  
Codice

T07093 27

**A**Code  
Codice

T07093 30

**B**

T07193 27

T07193 30

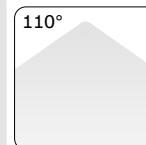
Beam angle  
Angolo del fascio

EXTRA WIDE

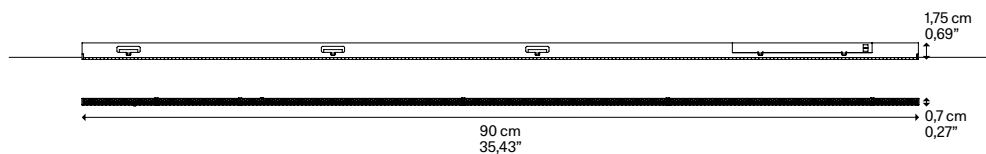

Net weight 145 g  
Peso netto 0,31 lbs

Pack 1  
Colli

